

USER MANUAL



Thank you for choosing Better Bathrooms.
Please read this manual before installing your product
and keep for future reference.

better 
bathrooms

Product

ARIMB013 - Arissa Matt Black 120mm Ceiling Arm

ARIBB014 - Arissa Brushed Brass 120mm Ceiling Arm

ARIMB014 - Arissa Matt Black 355mm Wall Arm

ARIBB015 - Arissa Brushed Brass 355mm Wall Arm

ARIMB015 - Arissa Matt Black 250mm Slim Shower Head

ARIBB016 - Arissa Brushed Brass 250mm Slim Shower Head

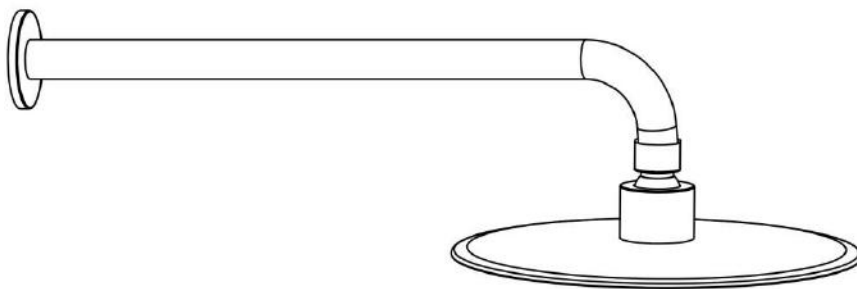
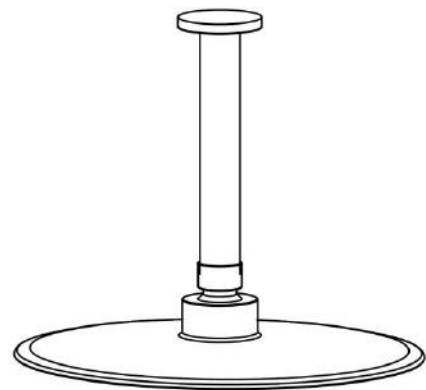

- **Single-person assembly**
- **We always recommend using professional tradespeople to install your product**

V2_3/9/2022

Congratulations on your purchase

And welcome to our growing gang of savvy shoppers

We're on a mission to bring you extraordinary bathroom products, for less. From modern to traditional style ceramics, plus the gorgeous fixtures, fittings and furniture to match. So, you can fall in love with your space every single day.

As one of the UK's largest independent bathroom stores, we've received countless awards; including the National Business Awards UK, the Digital Entrepreneur Awards and being placed on The Sunday Times Fast Track 100.

We hope your new product goes above and beyond your expectations. However, should any problems occur, please:

- log in to your account and contact our customer services team via your self-serve portal – betterbathrooms.com/Account/Login
- contact us via betterbathrooms.com/contact-us

Important information

- Please read these instructions thoroughly and retain for future reference
- Installation must be carried out in compliance with The Water Fittings Regulations and Scottish Water Byelaws.
- The system must be flushed prior to installation, else it might clog the filter and the following phenomenon occurs: discharged water volume is small, or temperature cannot be controlled well.
- Minimum and Maximum working pressure : 0.5 - 5 bar
- Pressures must be equal for optimum performance
- Please do not connect hot and cold water supply lines in reverse. This could result in hot water flowing from cold line and cause scalding.
- The feed-water temperature of water shall not exceed 85°C. Exceeding 85°C may cause scalding, the service life of faucets might be shortened, or the faucet might be damaged.
- After installation, please make sure the faucet is securely mounted and checked for leaks.

Parts / Diagrams

	No	Part Description
	1	Shower Arm
	2	Wall trim

	No	Part Description
	1	Shower Arm
	2	Wall trim

	No	Part Description
	1	Washer
	2	Shower head

Dimensions

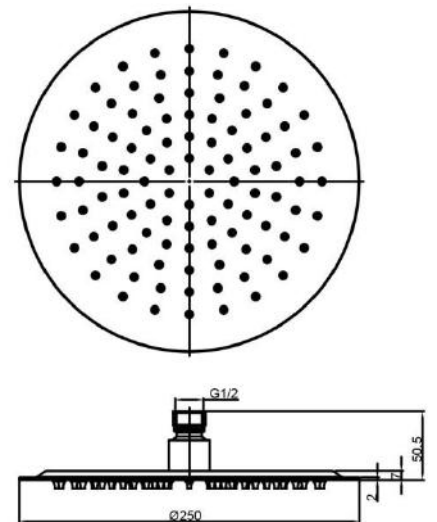
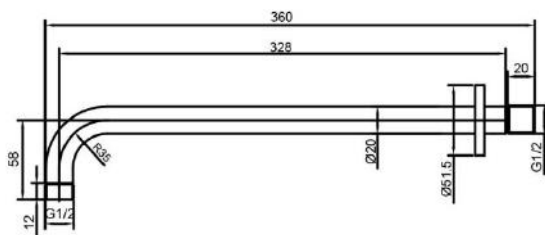
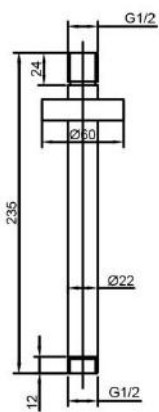

Tools required

- Seal tape

Installation

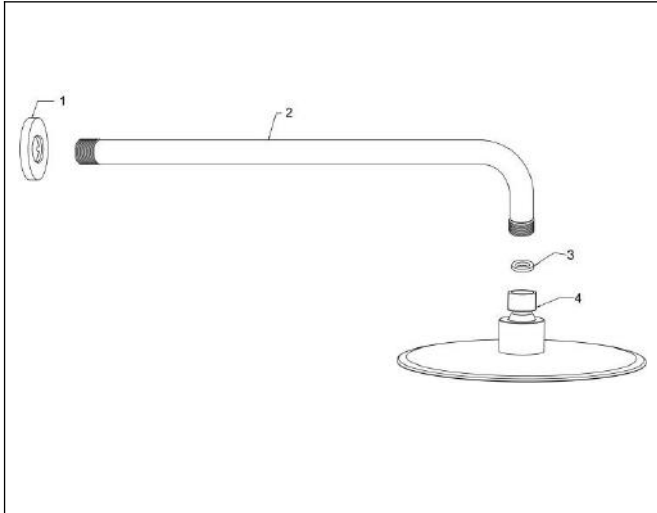

Wall-mounting type(same method for ceiling-mounting type)

- Put the trim cover(1) onto the wall arm(2).
- Apply an appropriate amount of seal tape on screw thread of wall arm(2), and screw the wall arm(2) in the water supply pipe elbow installed in the wall (not included), and adjust the wall arm(2) so that the bend points directs vertically down.
- Inspect and check if the rubber washer(3) is fitted in the ball-joint of shower head.
- Screw the shower head(4) with wall arm(2) by rotating the shower head and ensure it is fully tightened.

Troubleshooting

Issues	Check
Poor water flow	<ul style="list-style-type: none"> • Is there damage or blockage with filter mesh inside the ball joint of shower head • Are the nozzles of the shower head blocked
Water leak	<ul style="list-style-type: none"> • Is the shower head fully tightened to the arm • Have the seals been fitted • Has sufficient seal tape been used • Is there damage or blockage within the filter mesh inside the ball joint of shower head • Is there damage to the rubber washer in the ball joint of shower head

Maintenance and Cleaning

To maintain the surface of your product, wipe with a clean damp cloth and wipe dry, do not use any abrasive cleaning agents or materials.

If any harsh chemicals come into contact with the surface of the product, rinse and wipe clean immediately.

If the nozzle is blocked and flow distorted, wipe it with soft cloth which is dipped into warm water.

Take care not to damage the nozzles.

If the product is wiped with excessive force, the nozzle might become damaged or deformed, causing distorted flow.

For more information

- visit betterbathrooms.com
- email customerservices@buyitdirect.co.uk
- call 03303903062
- write to Trident Business Park, Neptune Way, Huddersfield, HD2 1UA

better 
bathrooms

Part of the BuyItDirect Group